

Zebec has developed strengths in conceptual, basic and detailed design. Our focus is to help achieve the right balance in terms of design and operational characteristics for the vessel.

Apart from concept and new build design, we also carry out conversion design for various vessel type including tanker to FPSO and other floaters.

Pre-bid engineering work is also carried out to assist large engineering companies to bid for lucrative Oil and Gas projects.

Conceptual Design

Zebec can provide assistance to develop outline design and specifications

Core processes:

- Determination of the size and platform (main dimensions)
- Estimation of steel weight
- Determination of the propulsion package selection basis:
 - Speed specifications
 - Quantity and capacity of various machinery
- Preparation of Technical Specifications
- Preparation of General Arrangement Plan

Basic Design

- Hull form design and optimization
- Detailed technical specifications
- Finalized general arrangement
- Hydrostatics & stability calculations
- Main scantling computations
- Structural design
- Equipment selection
- Machinery and Systems design
- Electrical design
- Safety and navigation

Vessel Conversion Design

Zebec is capable of handling various conversion turnkey projects such as:

- Bulk Carrier to Transshipment vessel
- Tanker to Bulk Carrier conversion
- Hydrographical survey to Seismic survey vessel
- Fishing trawler to Oceanographic Research vessel
- DP2 conversion
- Gondola and trolley design for Seismic survey vessel
- Heli-deck structure design
- PSV to DSV

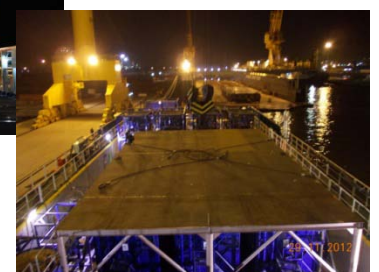
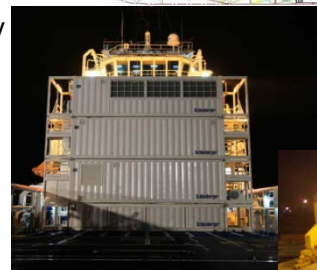
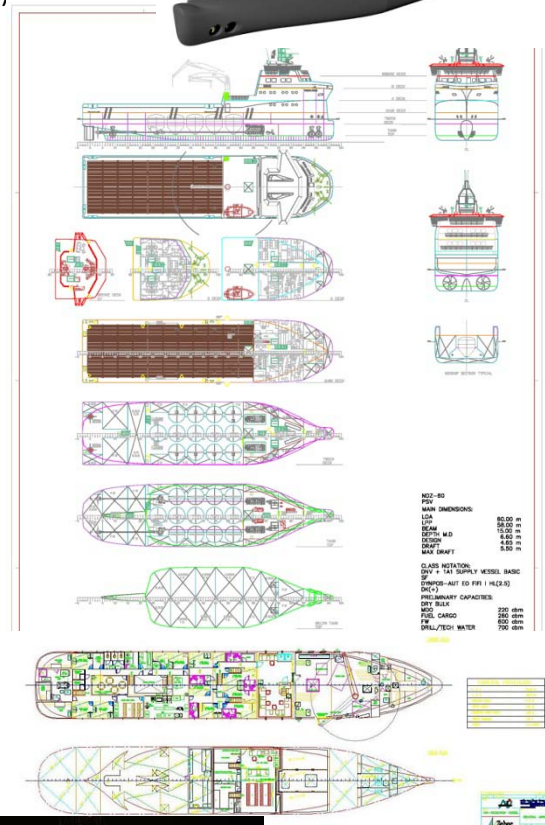

Production / Detailed Design

Zebec has, through its experience in basic design, acquired the capability for detailed design using Class approved Ship Constructor software.

The capability extends to preparation of the under-mentioned production drawings:

- Product hierarchy
 - Defines assembly sequence and build strategy
- Hull and Structure
 - Creates complex surface models and Pin jig drawings
 - Provides features such as plate parts, stiffeners, corrugated plates.
- Weld management
 - Creates welding schedules
- Nest and Profile
 - Creates nesting files
- NC PYROS
 - Configures direct interface to CNC machine for cutting
- Equipment
 - Models all equipment and inserts into the ship model
- Pipe
 - Complete 3D production model for pipe systems
- Electrical
 - The ability to model Electrical Cable Supports within Space Allocations
 - Wireway model drawing - a unit bound drawing for modeling space allocations and cable supports
 - Wireway arrangement drawing - a general electrical production drawing
- HVAC
 - Easily creates complex HVAC runs relative to structure
- Penetrations
 - Allows the creation of intelligent penetration through structural members
- Reports
 - Allows for definition and maintenance of complex production detail reports.

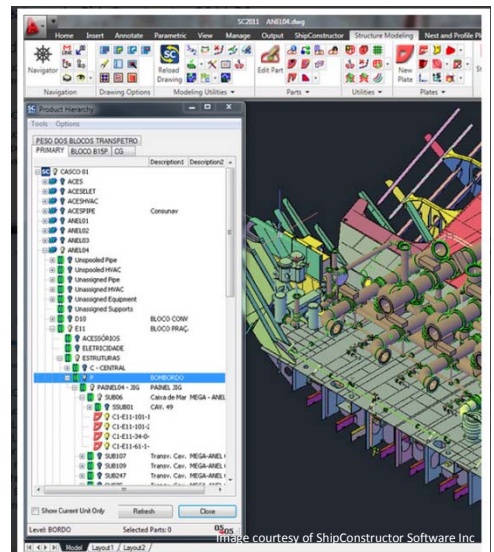
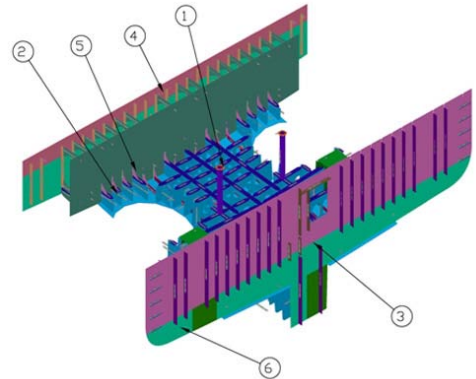

Offshore Design & Engineering

Our offshore design and engineering capabilities are complemented by Class approved software owned by us. We undertake the following design work:

- FPSO Basic Design and Engineering
- Green Water Analysis
- Tandem Offloading Analysis

- Mooring Analysis
 - Static Analysis
 - Dynamic & Fatigue Analysis
 - Quasi Static Analysis
 - Damage Analysis
 - 4, 8 & 12 Point mooring analysis
- DP Capability Study
- Loadout Services

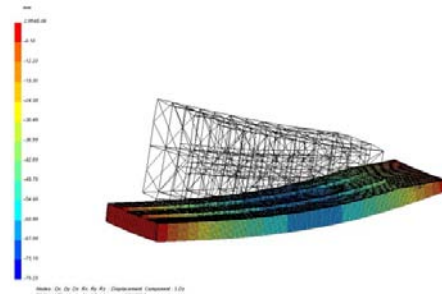

Vessel Hull Modeling

Hull modeling is carried out using our Bureau Veritas Class approved software namely:

- VeriSTAR Offshore
- Isy most – pre and post processor for FEM analysis
- New Strudl Offshore (NSO) – FEM solver for analysing various structure types
- HydroSTAR – for hydrodynamic analysis
- Ariane - For mooring analysis

In it's true sense VeriSTAR Offshore is essentially a general purpose finite element program specially tailored to cater to the needs of offshore industry.

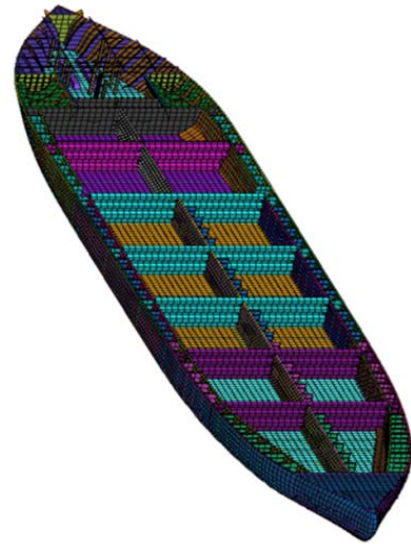

The unique features of the program are:

- Its ability to carry out a hydro-structure coupling analysis
- Enables the designer to carry out a complex coupling analysis based on limited inputs of site specific met-ocean data and vessels loading conditions
- Both extreme strength and fatigue analysis can be carried out with relative ease along with the assessment of buckling strength and code checking

Isy most is used extensively to model space frame structures as well as stiffened plated structures. These include:

- Space frame structures of machinery foundations
- Heli deck structures
- Two hold models of ship structures
- Construction of global FEM models of tankers and FPSOs

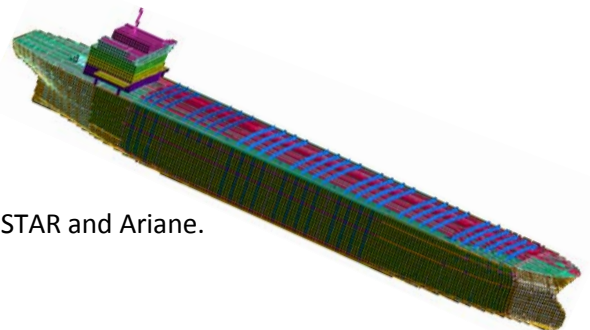

Hydrodynamic and mooring analysis is carried out using HydroSTAR and Ariane.

Unique features of HydroSTAR are:

- Ability to carry out multi-body hydrodynamics
- Analysis includes both deep and shallow water applications
- Directional splitting of waves are handled with relative ease
- Generates the RAOs based on which short term and long term values are predicted

With Ariane a variety of mooring analysis can be carried out. These include:

- Spread mooring system
- Turret mooring system
- Tandem offloading system
- Ship to Ship (STS) and various configurations involving multi-body system

Vessel Structural Analysis & Fatigue Analysis

At Zebec, we utilize a modern approach to model structural issues using specialist software. Our capability includes a wide range of structural design, investigations using appropriate Finite Element Analysis (FEA) Techniques. Using sophisticated software tools, we are able to properly complement traditional methods using Plate and Beam Theory

- Global finite element analysis (FEM)
- Longitudinal strength analysis
- Stress analysis for static & dynamic loading
- Vibration analysis
- Fatigue analysis
- Life extension studies

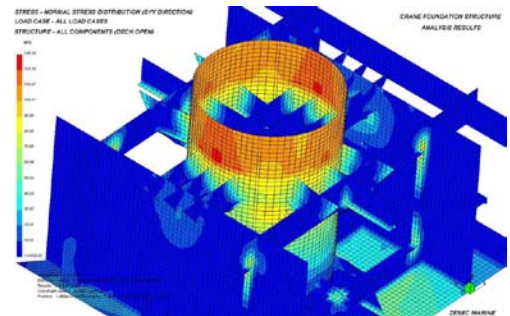

Ship Repair & Modification Design

Zebec specializes in repair and modification design. These are normally fast track design projects that need to be executed quickly and with careful consideration to individual vessel peculiarities.

Core activities:

- Preparation of detailed repair specifications
- Preparation of bill of materials (BoM)
- Detailed repair / modification drawings for shipyard production team
- Final as-fitted drawings post repair

Transhipper Design, Transshipment Analysis and Solutions

Zebec has acquired full capability to design and analyze the operational capability of Transhipper vessels.

Our material handling designs are simple to engineer, being essentially “bolt-on” type and offer the flexibility to trade the vessel as a specialized Transhipper and to revert to a normal Bulk carrier mode if the Owner so chooses at a later date.

Core processes:

- Conceptual Transhipper Design
- Numerical modelling of site conditions to assess operational downtime
- Multi-body Simulation
- Barge operations for definition of required handling rates and transhipper storage
- Anchoring and Mooring of Transhippers
- Financial viability analysis of transhipper deployment
- Ship-to-ship manoeuvring simulation
- Detailed Design of transhipper
- Selection of secondhand vessels for conversion to a transhipper